

2008 Model Tester

Operating Instructions



2008 Model Tester

Model 2008 Tester Parts

1. Operating Nut
2. Digital Gauge
3. Load Spreading Bridge
4. M20 Connecting Rod
5. M20 Adjustable Nut
6. 22mm Ratchet Spanner
7. Threaded Adaptors M12-M30
8. Spirit Level



Model 2008 Bridge Footprint

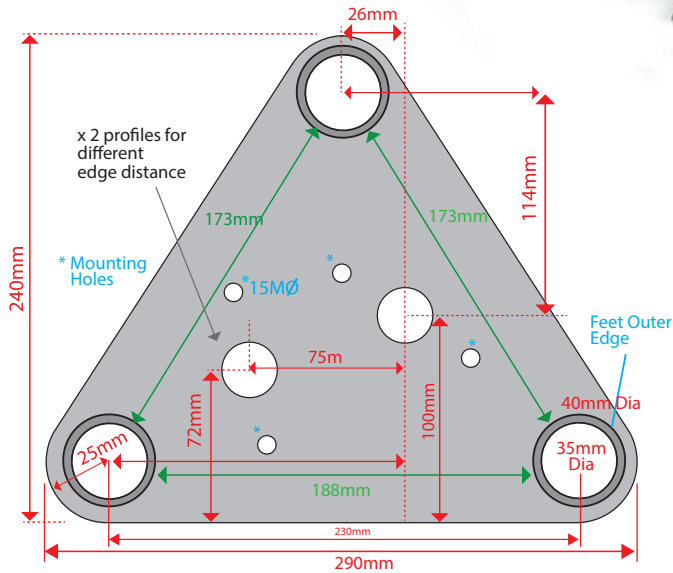

GENERAL DESCRIPTION

The Hydrajaws model 2008 Heavy Duty Tester is designed for establishing linear loading of mechanical and resin anchors, eye type anchors, threaded bar, re-bar and structural bolts and fixings to a maximum load of 145kN.

TECHNICAL SPECIFICATIONS

Intelligent digital pressure gauge

- 0-145kN (4 segment LCD display)
- Accurate to +/-2.5% FSD
- Indication of pull-out load
- Rise and fall output
- Maximum load achieved function
- Calibration in kN
- Traceable Calibration Certificate supplied valid for 1 year
- Material: stainless steel and ceramic
- Battery Powered (PP3)

USE OF THE TESTER AS DIRECTED

The tester is intended for use by skilled personnel with the appropriate training and knowledge of the applicable safety precautions.



It is essential that the operating instructions are read before the tester is operated for the first time.

Always keep these operating instructions together with the tester.

Ensure that the operating instructions are with the tester when it is given to other persons.

CONTENTS

| | <i>Page</i> |
|--|-------------|
| 2008 Model Tester Parts | 2 |
| General description | 3 |
| Technical Specifications | 3 |
| Kit contents | 4 |
| 1. LOAD SPREADING BRIDGE - set up | 5 |
| 2. General Testing Procedure - set up | 6 |
| 3. General Testing Procedure - Operating the tester | 7 |
| 4. Eyebolt Testing | 8 |
| 5. Re-bar operating instructions | 9 |
| 6. 2008 MODEL TESTER ASSEMBLY TO 12.5 TON LOAD SPREADING BRIDGE | 11 |
| 7. Operating the digital gauge | 12 |
| 8. Operating instructions for optional Bluetooth Digital Gauge | 13 |
| 9. Changing the gauge battery | 14 |
| 10. Calibration/Repair/ Replacement of gauge | 14 |

SAFETY RULES

- Modification of the tester, or tampering with its parts is not permissible.
- Observe the information printed in the operating instructions applicable to operation care and maintenance.
- The tester and its accessories may present hazards when used incorrectly by untrained personnel or not as directed.
- Use only the genuine Hydrajaws accessories or ancillary equipment listed in the operating instructions.

KIT CONTENTS

1. Model 2008 Tester Body
2. 22mm Operating Nut
3. 0-145kN Digital Gauge
(Bluetooth version optional for recording data via suitable mobile device)
4. Offset Load Spreading Bridge plate with 10mm eye hook
5. 3 Telescopic legs with fully adjustable swivel feet
6. M20 Connecting Rod 400mm
7. M20 Adjustable Nut
8. M24 Ratchet Spanner
9. 5 Threaded Adaptors
M20 > M12, M16, M20, M24, M30
10. Spirit level
11. Allen Keys 6mm & 2.5mm
12. Spare case screws x 2
13. M8 & 40 Cap Heads x 2 & 2 spare
14. Spare battery
15. Carry Case with Foam Filler
16. Operating Instructions
17. Calibration Certificate



1. LOAD SPREADING BRIDGE - set up

The bridge has been designed specifically for the model 2008 tester and directs reaction loads away from the fixing (fig 1). The lightweight aluminium load spreading bridge fits in the carry case disassembled (fig 2). The bridge is simple to assemble and adjust. Three fully adjustable telescopic legs offer 11 height positions 25mm apart (fig 3). The legs are held in place with steel ball pins.

The swivel feet offer 10mm of fine adjustment.

 Do not exceed 10mm of feet extension.

The triangular shape bridge plate is deliberately offset to offer two different close to edge testing distances in relationship to the fixing under test.

The tester can be secured to the bridge plate in two positions with the supplied cap screws (fig 4). Securing the tester to the plate is not crucial when the tester is being operated in a horizontal position however is essential when the tester is in a vertical position or inverted.

Fig 1



Fig 2



Fig 3



Fig 4



2. General Testing Procedure - set up

Assemble the load spreading bridge.

Secure the tester to the bridge if appropriate.

Position the tester and bridge over the fixing and using the M20 connecting rod pass this through the tester and bridge (**fig 5**).

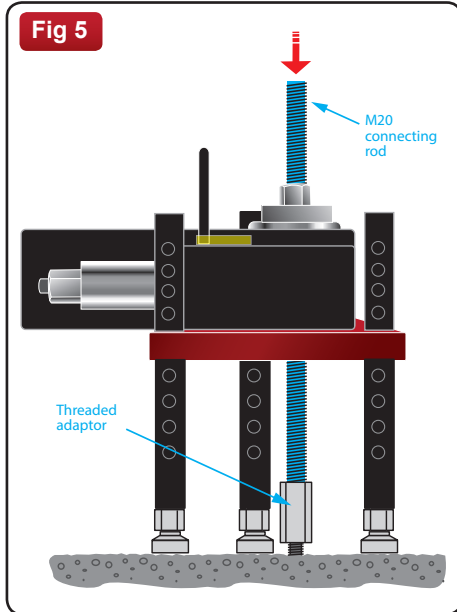

Connect the M20 connecting rod to fixing using the appropriate threaded adaptor (**fig 6**).

The standard tester kit features five metric threaded adaptors:

M20>M12, M20>M16, M20>M20,
M20>M24 or M20>M30.

Note: Other metric thread sizes are available via special order.

Imperial UNC adaptors are available from stock.

Sizes; 3/8", 1/2", 5/8", 3/4" & 1"

Install M20 adjusting nut (**fig 7**) on top of the threaded pull rod.



Adjust the 3 telescopic legs to an appropriate height, take up any initial slack using the threaded pull rod so that the fixing under test remains connected with no movement between the connecting rod nut and the top of the tester.

Ensure the tester is level by adjusting the swivel feet against the level bubble on the top of the tester body (**fig 8**).

Each threaded swivel foot features 30mm of fine adjustment.

Tighten with ratchet spanner (**fig 9**).



3. General Testing Procedure - Operating the tester

Switch the digital gauge on (see separate gauge operating instructions in this manual).

Commence applying the load to the fixing by turning the hexagon nut on the end of the operating piston in a clockwise direction by hand until tight or reading appears on gauge.

Apply load using the ratchet spanner (**fig 10**) and observe the reading on the gauge until the required test load is reached. This reading could decay due to first movement or creep on the anchor. Continue to apply the load to the required reading and observe that the loading remains steady. Should a serious drop in the indicated load occur again, the fixing is likely to be insecure and should be investigated.

As the digital gauge is very accurate a drop off will be noticeable but this should stabilise after a period of time. If the reading continues to drop off, further investigation of the fixing would be required.

To release the load, reverse the ratchet ring spanner and turn the hexagon nut anticlockwise and observe the load reading on the gauge until it approaches zero. Unwind the operating nut by hand until it is resting on the stop and unwind the adjustable nut and remove.

DO NOT CONTINUE TO UNWIND AGAINST THE STOP, OTHERWISE SERIOUS DAMAGE WILL OCCUR.

Fig 10



WARNING

DO NOT unwind the piston past the stop!

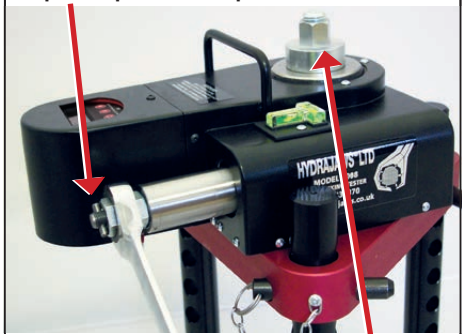

If after a test, the operating nut has been unwound fully however the top piston remains tight, untighten the adjustable nut with the ratchet spanner.

4. Eyebolt testing

1. Screw the M20 connecting rod into the heavy duty clevis and ensure the thread engages fully so it is flush with the block.
2. Adjust the 3 telescopic legs on the bridge so that the pin lines up with the eye under test. Place the pin through the eye and secure the clevis and pin.
3. Take up any further slack by either adjusting the thread on the feet and/or tightening the M20 adjustable nut.
4. Apply the load by operating the ratchet spanner clockwise observing the reading on the gauge.
5. After the test release the load by operating the ratchet spanner anti-clockwise and remove the clevis and pin.



Heavy duty clevis sizes

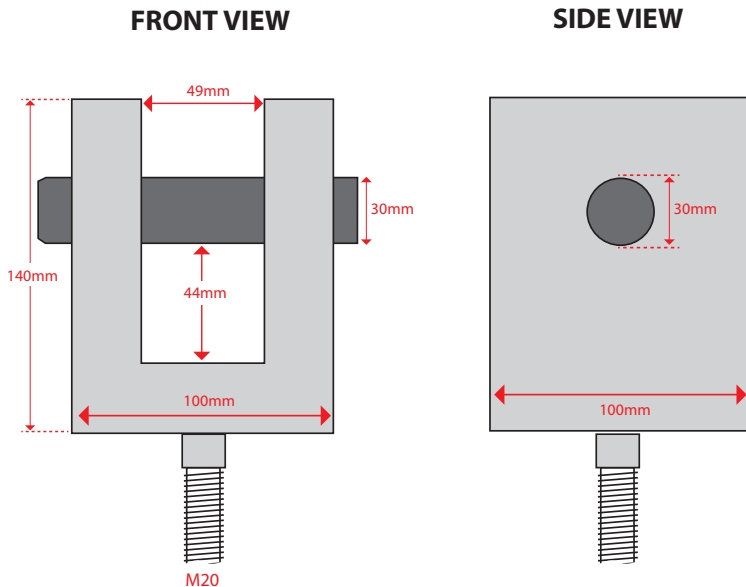

5. Re-bar operating instructions

1. The Model 2008 Portable Heavy Duty Tester will accept Rebar adaptors 6mm, 8mm, 10mm, 12mm, 14mm, 16mm, 18mm, 20mm & 22mm re-bar directly through the cylinder.
2. Place the tester and triangular load spreading bridge directly over the re-bar by passing through the cylinder hole.
3. Place the tapered barrel over the re-bar with the smaller diameter to the bottom until it rests on top of the cylinder. Insert the collet (3pcs) into the barrel and this will sit flush or just inside (**fig 11**) .
5. Adjust the fine thread at the base of each foot and on the triangular load spreading bridge legs by turning each foot clockwise until all the slack is taken up and the collet has gripped onto the re-bar. Failure to do this procedure may result in the tester running out of stroke. (10mm) (**fig 12**).
6. Ensure the tester is level by observing the spirit level on top of the tester case (**fig 13**).

Fig 11



Fig 12



Fig 13



5. Re-bar operating instructions *continued..*

7. Operate the tester by using the M24 ratchet spanner to the desired load (fig 14).
8. Once the test is complete, release the load fully and lower the threaded feet on each leg by turning the legs anti-clockwise. Full adjustment needs to be made so that the barrel can be removed from the collet.
9. Hit the top edges of the barrel with a hammer downwards until the collet can be removed, further adjustment to lower the bridge legs may be required. (fig 15).

Fig 14



Fig 15



6. 2008 MODEL TESTER ASSEMBLY TO 12.5 TON LOAD SPREADING BRIDGE

1. Screw the three M24 legs into the bridge to the desired height and adjust to a level position. (Lock the x3 M24 nuts to the underside of the bridge).
2. Remove the silver locating plate from the top of the bridge using the 5mm allen key and remove the 2 M8 x 15 counter sunk screws.
3. Secure the plate to the Model 2008 tester using holes marked A with the x 2 M8 x 25 counter sunk screws and this will allow the tester to be parallel when mounted on the bridge.
4. Holes marked B will allow the tester to be at 90 degrees to the bridge if required.
5. Secure the plate to the load spreading bridge with the x 2 M8 x 15 counter sunk screws (**fig 17**).
6. Spare screws are also provided for the tester assembly and bridge assembly.

Fig 16

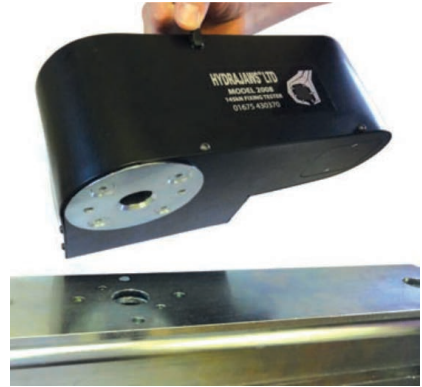

Fig 17



PLEASE NOTE THAT THE MAXIMUM CAPACITY OF THIS LOAD SPREADING BRIDGE IS 12.5 TON (125kN). This load should not be exceeded.

7. Operating the digital gauge

Operate Gauge in 'Normal rise and fall' mode

Press button  to switch gauge on to 'Normal rise and fall mode'.



This will give a load reading, rising as the operating handle on the tester is turned clockwise. By turning the handle anti-clockwise the load will decrease and show the reading decreasing.

Press  to switch off gauge when finished.

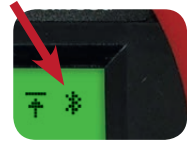
Note: When first turned on, a bluetooth symbol will flash in the right hand side of the screen. This is used for the Bluetooth Digital enabled version of the gauge and will normally stop flashing after 60 seconds.



Operate Gauge in 'Peak Hold' mode

1. Press button  to switch gauge on.
2. Press  to activate 'Peak Hold' mode.

This will be indicated by an arrow on screen.

Gauge is now in peak hold mode and will display the maximum load achieved and retain this even when the load has decreased.



To turn 'Peak Hold' mode on and off use the  button.

Activating the backlight

1. Press AND HOLD the  button to switch the backlight on and off.

To preserve battery life it is recommended the backlight is used only when needed and is switched off when the gauge is not in use.



To Zero the gauge

If the gauge is reading a small amount (0.3 for example) when no load is applied - use the following instructions to re-set the display to zero.

First release any pressure held in the Hydraulic Coupler by pushing in the pin at the base of the coupler.

1. Press AND HOLD the **A** button to zero the gauge



CAUTION:
DO NOT ZERO THE GAUGE
WHEN IT IS UNDER LOAD.



8. Operating instructions for optional Bluetooth Digital Gauge

Hydrajaws revolutionary digital technology captures test results using an Android or Apple mobile device and dedicated software application, allowing for instant visual graphs onsite for anchors & eyebolts. The digital system, using Bluetooth, produces real time visual graphs for each test.

To activate, first switch on the gauge. Then open the software application on the mobile device and press the Bluetooth connect button (**fig 18**).

A Bluetooth list will appear with a list of devices in range. Select the tester gauge to establish a connection. When a Bluetooth connection has been established the Bluetooth symbol on screen will stop flashing and remain on (**fig 19**).

Separate instructions for use of the Hydrajaws Bluetooth Digital will be provided. This details testing procedure and recording of results.



HYDRAJAWS[®]
Bluetooth™ **DIGITAL**

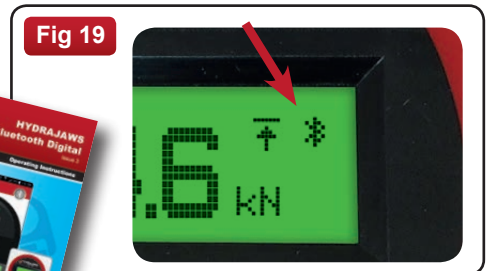

The Bluetooth digital gauge can be retro fitted to a Model 2008 tester.

9. Changing the gauge battery

Low battery



When the battery is low an indicator will appear on screen.

The battery can be replaced by unscrewing the cover on the back of the gauge using the 2mm allen key provided (**fig 20**). For access to the gauge - see section 10.

Please replace with a **6LR 61 9V** battery and fit as shown below.



To prevent damage to the contacts, always remove the battery as shown below.

Remove battery



Fit battery

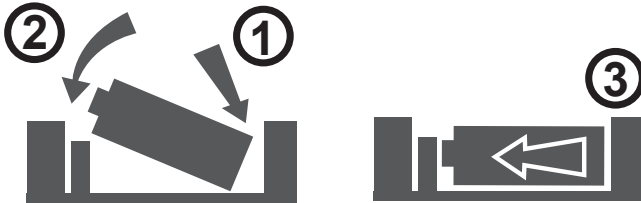

10. Calibration / Repair / Replacement of gauge

Removing the gauge

Access to the gauge is achieved by removing the front of the unit.

Remove the x5 M4 dome head screws with the allen key provided (**fig 21**).

Once undone the case will simply lift off.

This allows full access to the gauge.

If required, remove the gauge by reaching inside the case and disengaging the gauge from the hydraulic coupling by pulling the coupler connector back.

Fig 20

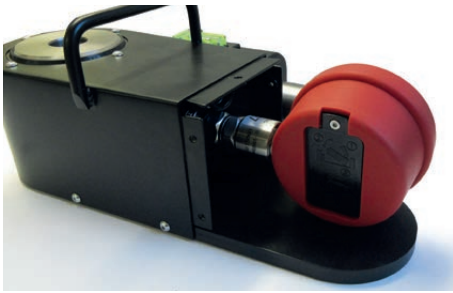
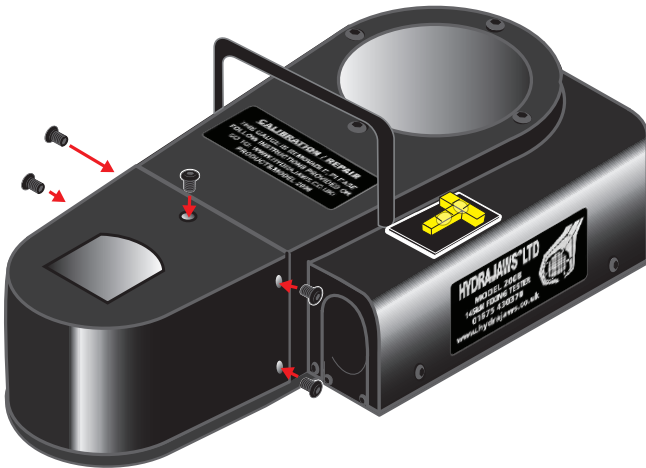
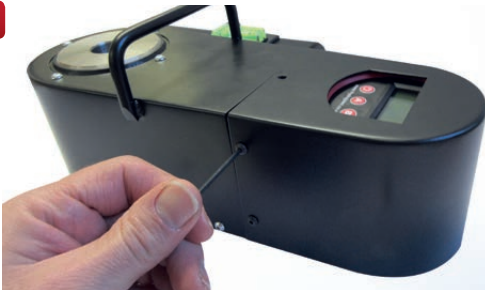

Fig 21



The x5 M4 dome head screws

**FOR MORE INFORMATION
ON HYDRAJAWS AND A
FULL RANGE OF TESTING
APPLICATIONS PLEASE VISIT
THE WEBSITE AT:
WWW.HYDRAJAWS.CO.UK**



20/21 The Courtyard
Gorsey Lane
Coleshill
Birmingham
B46 1JA, UK.

Tel: +44 (0)1675 430 370
Fax: +44 (0)1675 465 950

email: tester@hydrajaws.co.uk
www.hydrajaws.co.uk